

**Honeywell**

**ADEMCO 6271C  
ADEMCO 6271CV  
TouchCenter Keypads**

**Installation and  
Setup Guide**



# Table of Contents

.....

<b>SECTION 1 – General Information .....</b>	<b>1-1</b>
About the TouchCenter.....	1-1
System Features .....	1-1
Security .....	1-1
Setup .....	1-1
Compatibility .....	1-2
ECP Error .....	1-2
<b>SECTION 2 – Mounting and Wiring.....</b>	<b>2-1</b>
Mounting the TouchCenter Mounting Plate.....	2-1
Wiring the TouchCenter .....	2-2
<b>SECTION 3 – Front Panel LEDs and Navigation Icons.....</b>	<b>3-1</b>
Front Panel LEDs.....	3-1
Navigation Icons .....	3-2
<b>SECTION 4 – Initial Setup.....</b>	<b>4-1</b>
Programming the Control Panel.....	4-1
6271CV Word List .....	4-2
TouchCenter Initialization .....	4-3
Power Up.....	4-3
How to Change the ECP Address .....	4-3
How to Access the Central Station Screen .....	4-4
How to Select System Options.....	4-7
How to Set the NIGHT Setup Button Function .....	4-8
How to View and Edit Screen Security .....	4-9
How to View Code Authority.....	4-10
How to View the Panel Configuration.....	4-11
TouchCenter Setup .....	4-12
How to Adjust the TouchCenter Contrast.....	4-13
How to Adjust the Volume.....	4-14
How to Select Screen Backlight Off Activation Time.....	4-15
How to Select Homepage After Time .....	4-16
How to Set the Time and Date .....	4-18
Setting Operating Modes .....	4-22
<b>SECTION 5 – User Codes .....</b>	<b>5-1</b>
Introduction to User Code Setup .....	5-1
Authority Levels .....	5-1
How to Access User Setup .....	5-2
How to Add a User .....	5-4

How to Delete a User.....	5-6
How to Edit a User.....	5-7
<b>SECTION 6 – Maintenance.....</b>	<b>6-1</b>
About TouchCenter Maintenance.....	6-1
How to Clean the TouchCenter.....	6-1
Routine Care.....	6-3
<b>SECTION 7 – Troubleshooting.....</b>	<b>7-1</b>
Troubleshooting.....	7-1
Panel Fault Displays.....	7-1
Diagnostics.....	7-2
About Diagnostics.....	7-2
How to Access the Diagnostics.....	7-2
Performing Diagnostics.....	7-4
LCD Display Test.....	7-4
Audio Test.....	7-5
LED Test.....	7-6
<b>SECTION 8 – Safe Mode.....</b>	<b>8-1</b>
About the Safe Mode.....	8-1
Entering the Safe Mode.....	8-1
Automatic Entry.....	8-1
Manual Entry.....	8-2
Operating in the Safe Mode.....	8-4
Exiting the Safe Mode.....	8-5
<b>SECTION 9 – Specifications.....</b>	<b>9-1</b>
Specifications.....	9-1
<b>SECTION 10 – Index.....</b>	<b>10-1</b>

# Conventions Used in This Manual

---

Before you begin using this manual, it is important that you understand the meaning of the following symbols (icons) and text note.



The notes include warnings that must be followed to prevent an electrical shock.

---



These notes include specific information that must be followed if you are installing this system for a UL Listed application.

---



These notes include information that you should be aware of before continuing with the installation, and which, if not observed, could result in operational difficulties.

---

**Note:** These text notes are provided throughout the manual to provide informative information and shortcut tips for the installer.



## General Information

---

### In This Section

- ◆ *About the TouchCenter*
- ◆ *Compatibility*
- ◆ *System Features*

---

### About the TouchCenter

The 6271C and 6271CV are intuitive, graphical touch-screen keypads that combines security and home control. They can be used for:

- Quick and easy security system operation
- Control of the home environment, including lights and contains provisions for the future control of heating and air-conditioning.

---

**UL** The home environment control feature has not been evaluated by UL.

---

### System Features

#### Security

- Arm System
  - Away
  - Stay
  - Night
- Disarm System
- User Codes - Allows authorized user to add or delete codes
- Bypass Zones

#### Setup

- Volume
- Contrast
- Diagnostics
- Keypad Emulation (Console Mode)

## **Compatibility**

The below listing identifies the alarm systems that the TouchCenter can interface with, the maximum number of TouchCenters that can be used with each system, and the minimum alarm panel software revision level for compatibility.

<b><u>ALARM SYSTEM</u></b>	<b><u>MAXIMUM NUMBER OF TOUCHCENTERS</u></b>	<b><u>MINIMUM SOFTWARE REVISION LEVEL</u></b>
VISTA-15P	2	3.0
VISTA-20P	2	3.0
VISTA-20P	4	5.0
VISTA-20PS	2	All Levels
VISTA-20PS	4	5.0
VISTA-128BP	3	2.4
VISTA-128FBP	3	1.6
VISTA-250BP	3	2.4
VISTA-250FBP	1	1.5
VISTA-250FBP	3	2.0
FA148CP	2	3.0
FA168CPS	2	All Levels
FA1660C	3	2.4
FA1700C	1	1.5
FA1700C	3	2.0



- On all panels except the residential panels, you may obtain the software revision level of the alarm panel by entering the program mode and then entering #92 on the keypad. The second line of the keypad displays the software revision level (without the decimal point).
  - The keypad sound suppression feature available in some commercial panels is not compatible with the TouchCenter.
- 

## **ECP Error**

The message “ECP Error” will be displayed at the top of the screen (except for the Home screen) when the TouchCenter cannot communicate with the alarm panel. This may be caused by an incorrect ECP address in the TouchCenter or because AUI type devices have not been enabled in the panel. While this message is being displayed, you must use the TouchCenter default code of “4140” any time the TouchCenter requests an authorized code.



## Mounting and Wiring

---

### In This Section

- ◆ *Mounting the TouchCenter Mounting Plate*
- ◆ *Wiring the TouchCenter*

---

### Mounting the TouchCenter Mounting Plate



---

High Voltage is present inside the TouchCenter. DO NOT attempt to open the TouchCenter case. The TouchCenter DOES NOT contain any field replaceable parts.

---

The TouchCenter should be mounted using the following criteria:

- The TouchCenter must be mounted **indoors**, and
- should be mounted at eye level for easy viewing by the user.

To mount the TouchCenter mounting plate, complete the following steps:

1. Detach the mounting plate from the TouchCenter by pushing it toward the bottom of the TouchCenter.
2. Locate the mounting plate over the mounting surface such that the opening in the mounting plate is aligned with the wire/cable access opening (in the mounting surface) while passing the wires/cable through the opening in the mounting plate. (See Figure 1.)

**Note:** The back of the TouchCenter has wire channels leading to the bottom and the left side if surface wiring is being used.

3. Secure the mounting plate to the mounting surface using four screws (supplied).

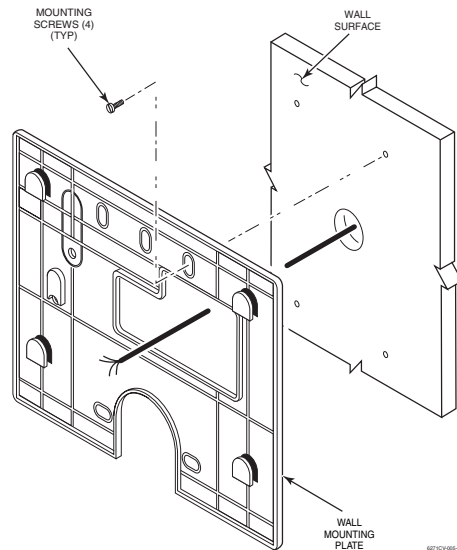

**Figure 1. Mounting the TouchCenter Mounting Plate**

### **Wiring the TouchCenter**

Connect TouchCenter in parallel with keypads and other peripheral devices using the keypad data (ECP) bus. To wire, see the Summary of Connections diagrams at the back of this guide, or the appropriate Systems Interconnection Diagram provided, and follow the instructions below.



---

Unshielded 4-conductor cable is recommended for the power/data wire.

---

### **Connect the wires to the TouchCenter terminal block as follows:**

1. Connect +12VDC to the TouchCenter using step a or b below.
  - a. If powering the keypad from the control panel, connect the AUX + terminal of the control panel to the + terminal block position (+12VDC terminal of the TouchCenter (red wire)).

- b. If powering the keypad from a supplementary power supply, connect the + terminal of the supplementary power supply to the + terminal block position (+12VDC terminal of the TouchCenter (red wire)).

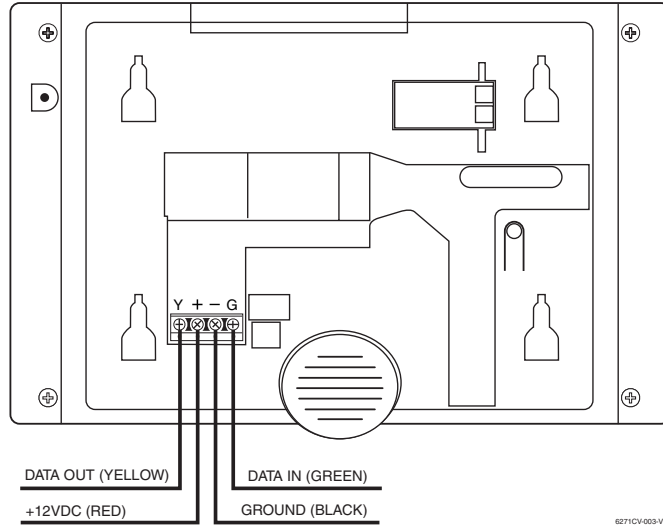

**Figure 2. Wiring the TouchCenter**

2. Connect ground to the TouchCenter using step a or b below.
  - a. If powering the keypad from the control panel, connect the AUX – terminal of the control panel to the – terminal block position (GND terminal of the TouchCenter (black wire)).
  - b. If powering the keypad from a supplementary power supply, connect the AUX – terminal of the control panel to the (–) terminal of the supplementary power supply (black wire). Then, connect the (–) terminal of the supplementary power supply to the – terminal block position (GND terminal of the TouchCenter (black wire)).
3. Connect Data Out terminal of the control panel to the Y terminal block position (Data In terminal of the TouchCenter (yellow wire)).
4. Connect the Data In terminal of the control panel to the G terminal block position (Data Out terminal of the TouchCenter (green wire)).

5. Mount the TouchCenter onto the mounting plate as shown in Figure 3.

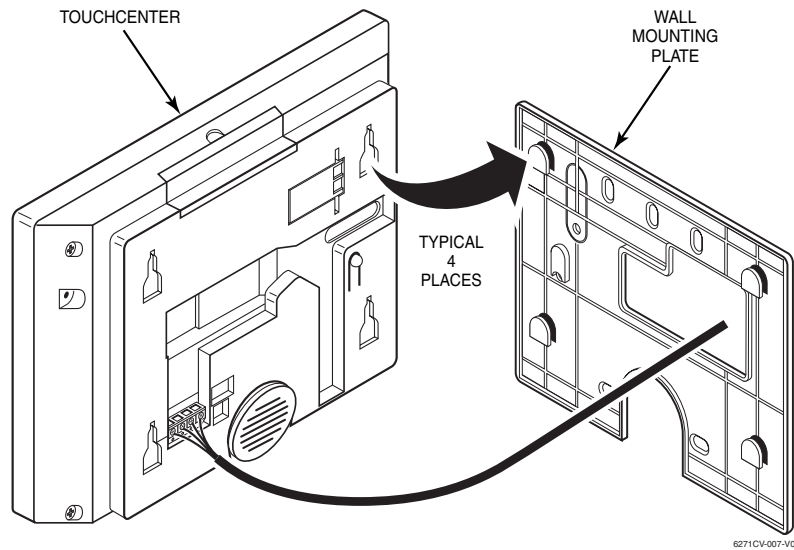

**Figure 3. Mounting the TouchCenter**

## **Front Panel LEDs and Navigation Icons**

**In This Section**

- ◆ *Front Panel LEDs*
- ◆ *Navigation Icons*







**Front Panel LEDs**

The TouchCenter has three LEDs labeled - ARMED, READY and TROUBLE (6271C) or MESSAGE (6271CV). The ARMED LED is red, READY LED is green and TROUBLE or MESSAGE LED is yellow. Each LED's on and off state has different meanings as described below.

LED	DESCRIPTION
ARMED	ON – Security system is armed. OFF – Security system is not armed.
READY	ON – Security system is disarmed and ready to arm. OFF – Security system is armed or disarmed but not ready. If disarmed, faults or troubles are present.
MESSAGE (6271CV)	FLASHING – The 6271CV contains new message(s) for the User OFF – No new messages.
TROUBLE (6271C)	ON – The Security System has one or more Trouble(s). OFF – No Trouble.

## Navigation Icons

To aid in the navigation through TouchCenter screens, a set of user-friendly icons has been provided. The appearance, function, and location of these icons is described below:

ICON	LOCATION	FUNCTION
	"Home" screen	Allows you to record and retrieve voice messages. (6271CV Only)
	"Home" screen	Allows you to turn certain devices on and off (if installed and programmed by your installer.)
	"Home" screen	Accesses "Arming" screen. <b>Note:</b> The lock symbol and lock color in the button indicates security system status. Unlocked and green – system disarmed Unlocked and yellow – system disarmed and a system trouble exists Locked and red – system armed
	Upper left corner of most screens	Returns you to the TouchCenter "Home" screen.
	Upper right corner of most screens	Reverts to the last screen viewed.
	Lower right corner of screen	Displays Emergency functions (as programmed by the installer). <b>Note:</b> This icon is displayed and active on all screens except while in the Clean Screen mode and during an LCD Display test in Diagnostics.

## Initial Setup

.....

### In This Section

- ◆ *Programming the Control Panel*
- ◆ *How to Access the Central Station Screen*
- ◆ *TouchCenter Initialization*
- ◆ *TouchCenter Setup*
- ◆ *How to Change the ECP Address*
- ◆ *Setting Chime Mode On / Off*

.....

### Programming the Control Panel

The TouchCenter will not be fully operational unless its address in the control panel has been enabled for an alpha console, AUI type device, and assigned to a partition (where applicable). Refer to “Compatibility” on page 1–2 of this document for the quantity of TouchCenters that may be used and the required control panel software revision level.

**Note:** When programming your control panel, if you change the zone types for your emergency zones you may disable the emergency buttons in the TouchCenter. The emergency buttons in the TouchCenter are active for zone types 06 and 07 (Panic button), 08 (Medical button), and 09 (Fire button).

**On residential control panels (VISTA-20PS or equivalent),** up to four TouchCenters may be used (addresses 1, 2, 5 and 6). Addresses 1 and 2 (in field \*189) are enabled by default. If the defaults have been changed, enable these addresses (in field \*189) using an alpha-keypad and the Data Field Programming procedures located in the panel Installation and Setup Guide.

**On commercial control panels (VISTA-128BP, VISTA-128FBP, or equivalent),** addresses 1, 2, and from 3 through 30 may be used for the TouchCenter. These addresses in the control panel are normally not defaulted for AUI type devices. To enable the addresses you will be using for TouchCenters, use an alpha-keypad and follow

the procedures for “Device Programming” in your control panel “Programming Guide.”

**Note:** If multiple TouchCenters are being used, they must be set to addresses 1, 2, and X (where X equals any address from 3 through 30). Only one AUI type device may be assigned to an address from 3 through 30 on commercial control panels.

### **6271CV Word List**

The 6271CV has the capability of enunciating the words listed below. Please note that this listing does not increase the vocabulary available from your panel. You must use the listing in your alarm panel instructions for actual words that may be requested for enunciation.

AC-Loss	Eighteen	Loading	Seventy
Air	Eighty	Low-Battery	Shed
Alarm	Eleven	Lower	Shop
Apartment	Emergency	Machine	Side
Area	Equipment	Main	Six-Hundred
Armed	Exit	Master	Six
Attic	Factory	Medical	Sixteen
Away	Father's	Mother's	Sixty
Baby	Fault	Motion	Sliding
Back	Fence	Night	Smoke
Bar	Fifteen	Nine-Hundred	Son's
Basement	Fifty	Nine	South
Bathroom	Fire	Nineteen	Station
Bed	First	Ninety	Stay
Bedroom	Five-Hundred	North	Storage
Blower	Five	Not	Supervise
Boiler	Floor	Now	Telco
Building	Forty	Off	Temperature
Bypassed	Four-Hundred	Office	Ten
Call	Four	On	Third
Carbon-Monoxide	Fourteen	One	Thirteen
Central	Foyer	One-Hundred	Thirty
Check	Front	Open	Three-Hundred
Closed	Garage	Outside	Three
Computer	Gas	Panic	Tool
Daughter's	Glass	Patio	Twelve
Den	Gun	Phone	Twenty
Detector	Hall	Police	Two-Hundred
Dining	Heat	Pool	Two
Disarmed	House	Power	Up
Disarm-System-Now	Hundred	Ready-to-Arm	Upper
Door	Inside	Rear	Upstairs
Down	Instant	Right	Utility
Downstairs	Kitchen	Room	West
Driveway	Laundry	Second	Window
Duct	Left	Service	Wing
East	Library	Seven-Hundred	Yard
Eight-Hundred	Light	Seven	Zero
Eight	Living	Seventeen	Zone



## TouchCenter Initialization

### Power Up

When initially powered, the screen displays the boot sequence as it is performed. After it is determined what services are available, the screen displays the Set ECP Address screen.

SCREEN	ACTION
	<p>If the system is incorporating only one TouchCenter, leave the address set to 1 and press the <b>APPLY</b> button. The boot-up process will continue until completion.</p> <p>If there are to be additional TouchCenter units in the system, refer to the <i>How to Change the ECP Address</i> paragraph.</p> <p><b>Note:</b> Use care when making selections on this screen. Touching the screen outside the prescribed areas may cause the background to come to the front. If this should occur, remove and re-apply power to the TouchCenter.</p>



### How to Change the ECP Address

After enabling addresses in the control panel using an alpha-keypad, power up each TouchCenter one at a time, and set its address to one of the addresses you enabled in the control panel. If this is a first time power-up of the unit, follow the initialization procedure in this section. Otherwise, access the Central Station screen then follow the procedure to change the address on the unit.

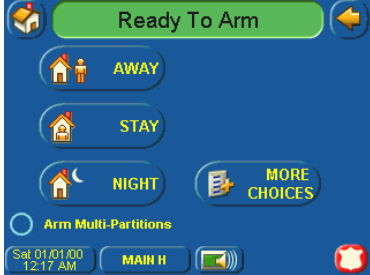

## How to Access the Central Station Screen

To Access the “Central Station” screen perform the following:

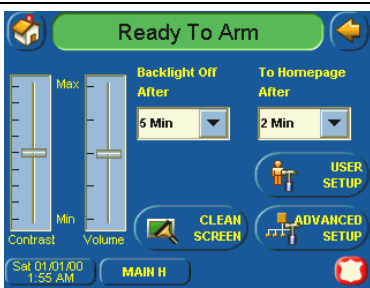
1. Press the **SECURITY** button on the “Home” screen. The “Arming” screen is displayed.

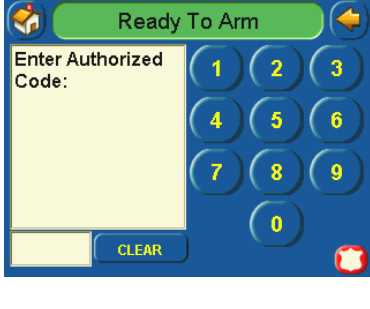

SCREEN	ACTION
	<ol style="list-style-type: none"> <li>2. Press the <b>MORE CHOICES</b> button. The “More Choices” screen is displayed.</li> </ol>
	<ol style="list-style-type: none"> <li>3. Press the <b>SETUP</b> button on the “More Choices” screen. The “Setup” screen is displayed.</li> </ol>
	<ol style="list-style-type: none"> <li>4. Press the <b>ADVANCED SETUP</b> button. The <b>Enter Authorized Code:</b> authorization screen is displayed.</li> </ol>

SECTION 4: Initial Setup

SCREEN	ACTION
 <p>The screenshot shows a blue interface with a green header 'Ready To Arm' and a back arrow. Below the header is a yellow box labeled 'Enter Authorized Code:' followed by a numeric keypad (0-9) and a 'CLEAR' button. A red shield icon is in the bottom right corner.</p>	<p>5. Enter your 4-digit Installer code. The “Advanced Setup” menu screen is displayed.</p> <p><b>Note:</b> If the top of the screen is displaying ECP Error, the ECP address in the TouchCenter is not valid for the panel that it is connected to. To change the ECP address in the TouchCenter when ECP Error is being displayed, enter the TouchCenter default code of “4140” to advance to the next screen.</p>
 <p>The screenshot shows a blue interface with a green header 'Ready To Arm' and a back arrow. Below the header are two buttons: 'CENTRAL STATION' (with a house icon) and 'KEYPAD TEST' (with a keypad icon). To the right, a box displays 'Software Version 0.0.4 - July 20, 2005'. At the bottom, it shows 'Sun 01.02.00 1:27 AM' and 'MAIN H' with a red shield icon.</p>	<p>6. Press the <b>Central Station</b> button. The “Central Station” menu screen is displayed.</p>
 <p>The screenshot shows a blue interface with a green header 'Ready To Arm' and a back arrow. Below the header are several menu items: 'ECP Address', 'Screen Security', 'Options', 'Night Setup', 'Device Events', 'Code Authority', and 'Panel Config'. It also displays 'Resets = 232' and 'Running 0:00:04:53'. At the bottom, it shows 'Sun 01.02.00 1:28 AM' and 'MAIN H' with a red shield icon.</p>	

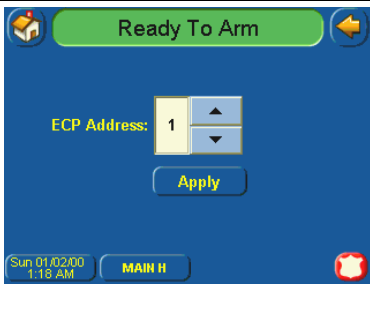

*TouchCenter Installation and Setup Guide*

To change the address, perform the following.

SCREEN	ACTION
	<p>1. On the "Central Station" screen press the ECP Address button. A pop-up window is displayed with options for selecting the TouchCenter's ECP address.</p>
	<p>2. The available ECP addresses are:          1-2, 5-6 for residential controls or          1-30 for commercial controls          Select the ECP address for this TouchCenter using the Up/Dn arrows. Press the <b>OK</b> button to accept the address setting or the <b>CANCEL</b> button to maintain the original ECP address. If <b>OK</b> is selected, the TouchCenter will reset. If <b>CANCEL</b> is selected, The "Central Station" menu screen is displayed.</p>
	

**How to Select System Options**

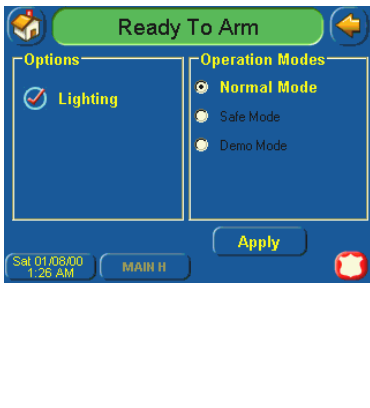
The system options allow you to place buttons on the "Home" screen. The **SECURITY** button is always displayed and cannot be removed. A Lighting button can also be added to the "Home" screen. To avoid confusion to the user, only buttons whose options are functional in the system should be displayed. To select the system options, do the following:



SCREEN	ACTION
	<p>1. On the "Central Station" screen press the <b>Options</b> button. A pop-up window is displayed with an option for selecting <b>Lighting</b>.</p>
	<p>2. Touch the Lighting button to turn the Lighting option on or off. A checkmark appears in the button when the Lighting option is "ON".</p> <p><b>Note:</b> DO NOT select the Demo Mode option. This option should only be selected if instructed to do so by factory service. When this option is selected, the keypad will not communicate with the control panel and any user can select Advanced Setup screens.</p> <p>Press the <b>Apply</b> button to accept the setting. The TouchCenter returns to the "Central Station" menu screen.</p>
	

### How to Set the NIGHT Setup Button Function

The NIGHT button can be set to arm the system in one of four arming modes:

- Away - When selected, arms all zones with entry delay.
- Stay - When selected, arms perimeter zones with entry delay.
- Instant - When selected, arms perimeter zones without entry delay.
- Night (Residential Panels Only) – When selected, arms all perimeter zones plus all zones listed in Zone List 5.
- Maximum - When selected, arms all zones without entry delay.

To set the NIGHT button function, do the following:



SCREEN	ACTION
 <p>The screenshot shows the 'Ready To Arm' screen with a green header and a blue background. A 'Night Setup' button is highlighted in the center-right area. Other buttons include 'ECP Address', 'Screen Security', 'Options', 'Night Setup', 'Device Events', 'Code Authority', and 'Panel Config'. At the bottom, it shows 'Resets = 232', 'Running 0:00:04:53', and a 'MAIN H' button.</p>	<p>1. On the "Central Station" screen press the <b>Night Setup</b> button. A Night Setup: pop-up window is displayed with options for selecting Away, Stay, Instant, Maximum and Night.</p>
 <p>The screenshot shows the 'Ready To Arm' screen with a green header and a blue background. A list of arming modes is displayed: 'Away', 'Stay', 'Instant', 'Maximum', and 'Night'. The 'Night' option is selected. An 'Apply' button is at the bottom. At the bottom, it shows 'Sun 01:02:00 1:44 AM' and a 'MAIN H' button.</p>	<p>2. Select the arming mode that will be activated by pressing the <b>NIGHT</b> button on the "Arming" screen. Press the <b>Apply</b> button to accept the setting, or press the <b>Back</b> button to cancel your selection. In either case the TouchCenter goes to the "Central Station" menu screen.</p>

SECTION 4: Initial Setup

SCREEN	ACTION
	

**How to View and Edit Screen Security**

The **Screen Security** button displays a screen that lists the various screen classes in the TouchCenter and lists what level user has been given access to them. To view and/or edit screen security, do the following:

SCREEN	ACTION
	<p>1. On the “Central Station” screen, press the <b>Screen Security</b> button. A listing of the classes of screens and the user level that has access to them will be displayed.</p>
	<p>2. If the listing is correct, depress the <b>BACK</b> button to return to the “Central Station” screen. If changes are necessary, select the line to be changed and a Setup screen will be displayed.</p> <p><b>Note:</b> The Setup screen contains a heading of Advanced Setup, Central Station Setup, Operating Modes, Event Logs, or Lighting indicating which line was selected for change.</p>

SCREEN	ACTION
	<p>3. Select the level of user who is to have access to the selected class of screens and then select the <b>OK</b> button. The Screen Security screen will be re-displayed listing the change. Depress the <b>BACK</b> button to return to the “Central Station” screen.</p> <p><b>Note:</b> The User Levels listed on this screen match the Users Levels in commercial panels. See the chart below for corresponding User Levels in Residential Panels.</p>

**Residential Panels and Screen Security**

Authority Level in Panel	Matching Authority Level in TouchCenter	Access Level Chosen in TouchCenter Screen Security					
		Installer	Master	Manager	Operator A	Operator B	Operator C
System Master	Master	No	Yes	Yes	Yes	Yes	Yes
Partition Master	Master	No	Yes	Yes	Yes	Yes	Yes
Standard User	Normal	No	No	No	Yes	Yes	Yes
Arm Only	N/A	No	No	No	No	No	No
Guest	Guest	No	No	No	No	Yes	Yes
Duress	N/A	No	No	No	No	No	No



**How to View Code Authority**

The **Code Authority** button displays a screen that contains the User Name and Partition Authority Level for for the User Code that in entered. To view the Code Authority level, do the following:

SCREEN	ACTION
	<p>1. On the “Central Station” screen press the <b>Code Authority</b> button. An Enter Authorized Code screen will be displayed.</p>

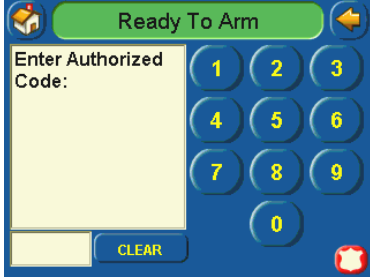

SECTION 4: Initial Setup

SCREEN	ACTION												
	<p>2. Enter the 4-digit User Code corresponding to the user that you want to obtain Authority Level information about. An Authority Level screen containing this information will be displayed.</p>												
	<p>3. Press the <b>BACK</b> button to return to the “Central Station Screen”.</p> <p><b>Note:</b> The User Levels listed on this screen match the Users Levels in commercial panels. See the chart below for corresponding User Levels in Residential Panels.</p> <p><b>Authority In Panel Level Shown As</b></p> <table border="0"> <tr> <td>Standard User</td> <td>Operator A</td> </tr> <tr> <td>Arm Only</td> <td>Unknown</td> </tr> <tr> <td>Guest</td> <td>Operator B</td> </tr> <tr> <td>Duress</td> <td>Duress</td> </tr> <tr> <td>Partition Master</td> <td>Master</td> </tr> <tr> <td>System Master</td> <td>Master</td> </tr> </table>	Standard User	Operator A	Arm Only	Unknown	Guest	Operator B	Duress	Duress	Partition Master	Master	System Master	Master
Standard User	Operator A												
Arm Only	Unknown												
Guest	Operator B												
Duress	Duress												
Partition Master	Master												
System Master	Master												

**How to View the Panel Configuration**

The **Panel Config** button displays a screen that contains the configuration of the panel that the TouchCenter is connected to. To view the panel configuration, do the following:

SCREEN	ACTION
	<p>1. On the “Central Station” screen press the <b>Panel Config</b> button. A Panel Configuration screen will be displayed providing details of your system.</p>

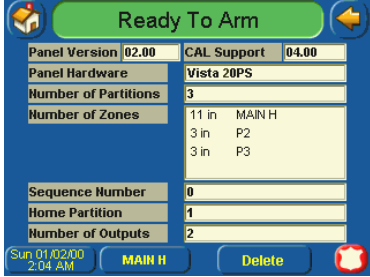
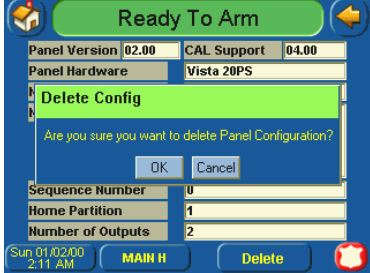
SCREEN	ACTION
	<p>2. Depress the <b>Back</b> button to return to the “Central Station” screen or if you desire to clear the configuration from the TouchCenter and have it reload the panel configuration into the TouchCenter from the panel, depress the <b>Delete</b> button. After you depress the <b>Delete</b> button, a confirmation screen is displayed.</p>
	<p>3. Select <b>OK</b> to delete the configuration or <b>Cancel</b> to return to the “Panel Configuration” screen. If you select OK, the TouchCenter will be reset and the panel configuration will be downloaded from the panel into the TouchCenter. After the reset and download is complete, the “Home” screen is displayed.</p>

## TouchCenter Setup

Setup allows you to make changes to the way your TouchCenter is operating. The options that can be changed are:



- Adjust the touch screen contrast
- Adjust the TouchCenter sounder volume
- Change the time interval that must pass prior to the TouchCenter turning off the touch screen backlight
- Change the time interval that must pass prior to the TouchCenter returning to the “Home” screen

Additionally, you may enter the **User Setup** screen, **Advanced Setup** screen (if enabled by your system installer), or **Clean Screen** (maintenance mode) from the "Setup" screen by pressing the corresponding button.

Access the "Setup" screen as follows:

1. From the "Home" screen, press the **SECURITY** button. The "Arming" screen is displayed.

*SECTION 4: Initial Setup*

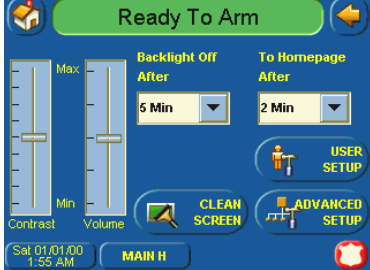
SCREEN	ACTION
	<p>2. Press the <b>MORE CHOICES</b> button. The "More Choices" screen is displayed.</p>
	<p>3. Press the <b>SETUP</b> button on the "More Choices" screen. The "Setup" screen is displayed.</p>
	<p>4. Adjust the TouchCenter options as described in the paragraphs that follow.</p>

**How to Adjust the TouchCenter Contrast**

You may adjust the TouchCenter contrast as follows:

If...	Then...
you want to increase contrast	move the slide bar above the current contrast setting.
you want to decrease contrast	move the slide bar below the current contrast setting.

If you have made any changes in the contrast settings, when you exit this screen you will be presented with a pop-up asking if you want to remember the new settings.

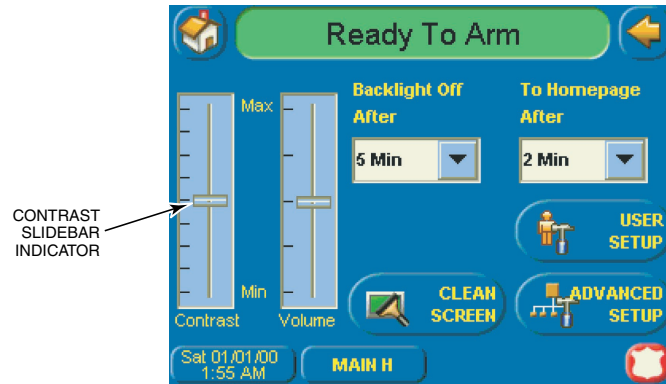

### ***TouchCenter Contrast Control***

#### **How to Adjust the Volume**

You may adjust the TouchCenter sounder volume by pressing your finger on the TouchCenter slide bar associated with the "Volume" scale and doing the following:

If...	Then...
you want to increase volume	move the slide bar above the current volume setting.
you want to decrease volume	move the slide bar below the current volume setting.

If you have made any changes in the contrast settings, when you exit this screen you will be presented with a pop-up asking if you want to remember the new settings.



**Volume Control**

**How to Select Screen Backlight Off Activation Time**

When the TouchCenter is not active, it will automatically turn the backlight off after the selected backlight off time has expired (unless “Never” option is selected). To select the screen backlight time, do the following:

SCREEN	ACTION
	<p>1. On the "Setup" screen, press the <b>Backlight Off After:</b> "arrow" button. A pop-up window displaying the time period options is displayed.</p>

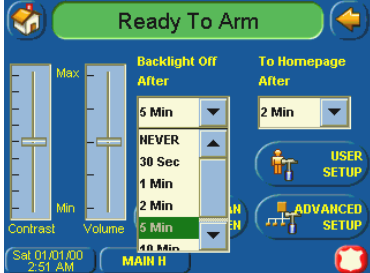
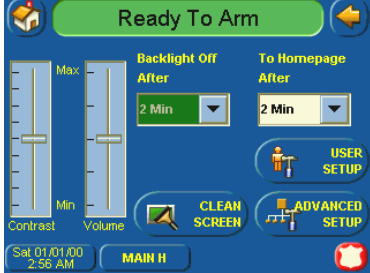
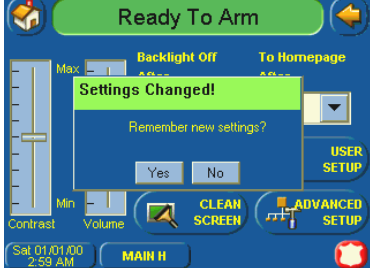
SCREEN	ACTION
	<p>2. Select the time period option you want by pressing it. The pop-up window closes automatically and the selection is displayed.</p> <p><b>Note:</b> Additional options can be viewed by using the up/down "arrows" to scroll through the time period options.</p>
	<p>3. Press either the "Home" or "Back" button. A <b>Settings Changed!</b> pop-up window is displayed asking <b>"Remember New Settings?"</b> Select <b>Yes</b> to save the change or <b>No</b> to discard the change.</p>
	<p>When the Update is complete the TouchCenter goes to the "Home" screen or "More Choices" screen depending on whether you pressed the "Home" or "Back" button, respectively.</p>

### How to Select Homepage After Time

When the TouchCenter is not active, it will automatically return to the "Home" screen after the selected To Homepage After time has expired (unless "Never" option is selected). To select the To Homepage After time, do the following:

SECTION 4: Initial Setup

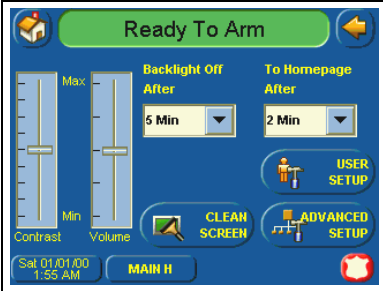
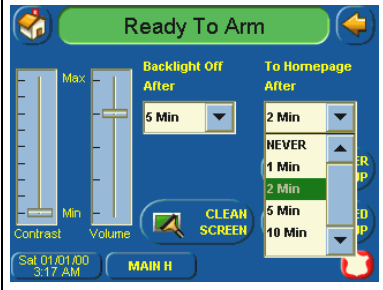
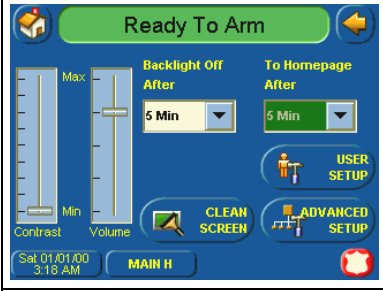
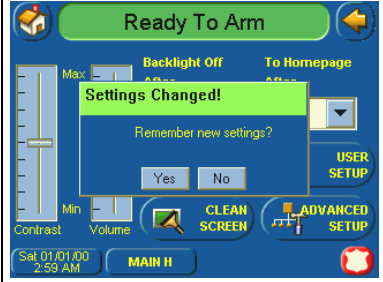

SCREEN	ACTION
	<p>1. On the "Setup" screen, press the <b>To Homepage After</b> "arrow" button. A pop-up window displaying the time period options is displayed.</p>
	<p>2. Select the time period option you want by pressing it. The pop-up window closes automatically and the selection is displayed.</p>
	<p>3. Press either the "Home" or "Back" button. A <b>Settings Changed!</b> pop-up window is displayed asking <b>"Remember New Settings?"</b> Select <b>Yes</b> to save the change or <b>No</b> to discard the change.</p>
	<p>When the Update is complete the TouchCenter goes to the "Home" screen or "More Choices" screen depending on whether you pressed the "Home" or "Back" button, respectively.</p>

### How to Set the Time and Date

You can set the time and date from the **Set Time & Date** screen. Pressing the Time and Date button located at the bottom of the TouchCenter screen displays the **Set Time & Date** screen.

- When the time is set it will be stored in the TouchCenter and sent to the control panel when you press the **Apply** button and answer **Yes** to the following prompt. Additionally, when using the TouchCenter with a residential panel, the panel will download its time into the TouchCenter once an hour after the clock is set.
- If **Get Time** is pressed, the TouchCenter will download the time and date from the control panel and exit the Set Time & Date screen. **Note:** This button appears with residential panels only.
- If **DST On** (Daylight Savings Time) is selected, the TouchCenter will adjust for Daylight Savings time beginning on the first Sunday in April and ending on the last Sunday in October.

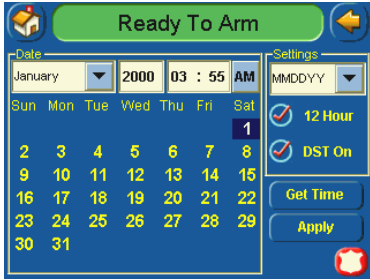
To set the time and date, press the Time and Date button located at the bottom of the screen and do the following:

SCREEN	ACTION
	<p>1. On the "Time and Date" screen, press the <b>Month/Day/Year</b> "arrow" button in the "Settings" area of the screen. A pop-up window displaying the Month/Day/Year display formats is displayed.</p>
	<p>2. Select the display format you want by pressing it. The pop-up window closes automatically and the selection is displayed.</p>

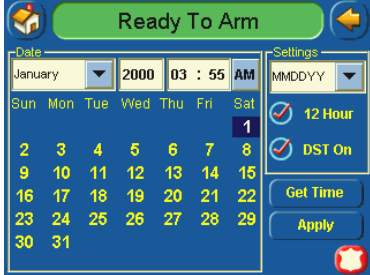
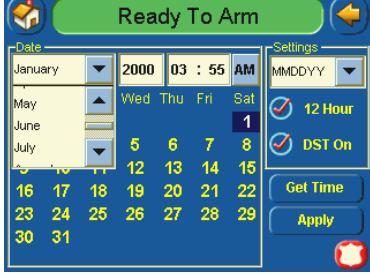
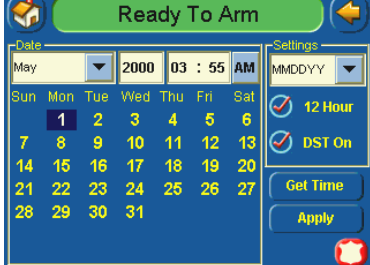

*SECTION 4: Initial Setup*

SCREEN	ACTION
	<p>3. Select if you want a 12-hour or 24-hour format for your time display by touching the circle to the left of the <b>12 Hour</b> display in the “Settings” area of the screen. A check mark in the circle indicates a 12-hour display format.</p> <p>4. Select if you want Daylight Savings Time to affect your system clock by touching the circle to the left of the <b>DST On</b> display in the “Settings” area of the screen. A check mark in the circle indicates that Daylight Savings Time is applicable.</p> <p>5. On the "Time and Date" screen, press the <b>Month</b> "arrow" button. A pop-up window displaying the months is displayed.</p>
	<p>6. Select the current month by pressing it. The pop-up window closes automatically and the selection is displayed.</p>
	<p>7. On the "Time and Date" screen, press the Year that is being displayed. A Year screen is displayed with the instructions to <b>Enter 4 digits for the year.</b></p>

*TouchCenter Installation and Setup Guide*

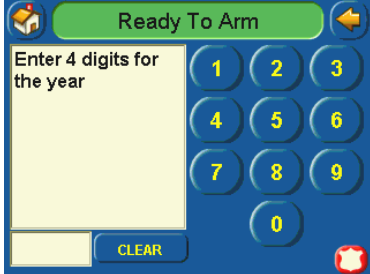
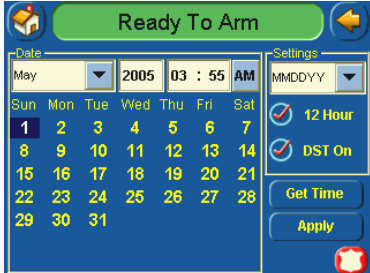
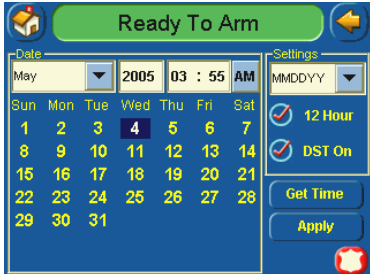
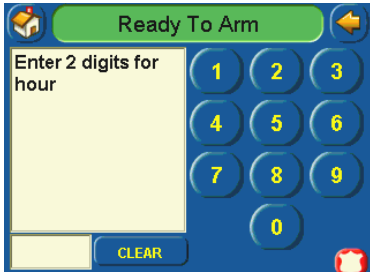
SCREEN	ACTION
	<p>8. Enter the four digits for the current year. The window closes automatically and the selection is displayed.</p>
	<p>9. Select if it is AM or PM by pressing on the <b>AM</b> or <b>PM</b> display on the screen. Each depression switches the AM/PM display.</p> <p>10. Select the day of the month by touching the proper day in the display. The selected date will be highlighted on the screen.</p>
	<p>11. On the "Time and Date" screen, press the Hour that is being displayed. An hour screen is displayed with the instructions to <b>Enter 2 digits for the hour</b>.</p>
	<p>12. Enter the two digits for the current hour. The window closes automatically and the selection is displayed.</p>

SECTION 4: Initial Setup

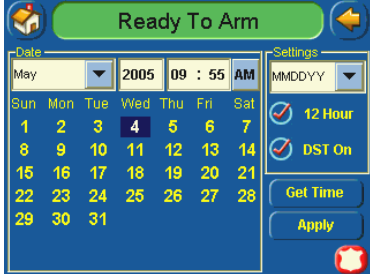
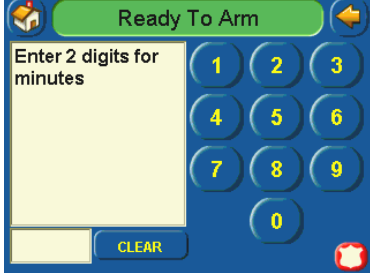
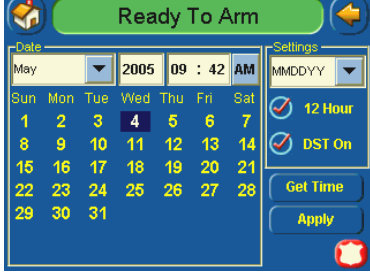
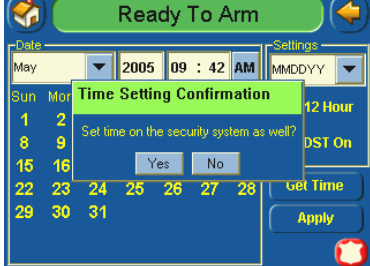
SCREEN	ACTION
	<p>13. On the "Time and Date" screen, press the Minutes that is being displayed. A minutes screen is displayed with the instructions to <b>Enter 2 digits for the minutes</b>.</p>
	<p>14. Enter the two digits for the current minute. The window closes automatically and the selection is displayed.</p>
	<p>15. On the "Time and Date" screen, press the <b>Apply</b> button. A confirmation screen is displayed.</p>
	<p>16. Press the <b>Yes</b> button to save the time changes in your security system or press the <b>No</b> button to have the changes affect the TouchCenter only. <b>Note:</b> A <b>Yes</b> response is recommended.</p>



## Setting Operating Modes

Operating modes allows you to turn the TouchCenter chime mode on or off. Additionally, when using the 6271CV you may also turn the voice mode on or off. The operating modes provide the following features:

- Chime Mode – When selected, a request is sent to the alarm panel requesting that the panel chime the TouchCenter whenever a change in zone status occurs.
- Voice Mode (6271CV Only) – When selected, a request is sent to the alarm panel requesting that the panel initiate TouchCenter voice enunciation whenever a change in system status occurs such as Armed, Disarmed, or Alarms.
- Voice Chime Mode (6271CV Only) – The chime mode and voice mode are in effect. When selected, you will get the chime beeps followed by voice enunciation.

Access the "Operating Modes" screen as follows:

1. From the "Home" screen, press the **SECURITY** button. The "Arming" screen is displayed.

SCREEN	ACTION
	<ol style="list-style-type: none"> <li>2. Press the <b>MORE CHOICES</b> button. The "More Choices" screen is displayed.</li> </ol>
	<ol style="list-style-type: none"> <li>3. Press the <b>OPERATING MODES</b> button on the "More Choices" screen. The "User Authorization" screen is displayed with the instructions "Enter Authorized Code".</li> </ol>

SECTION 4: Initial Setup

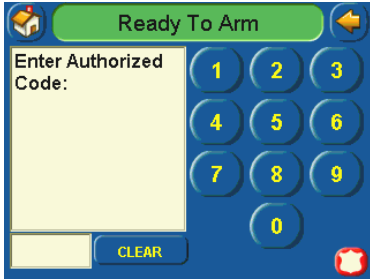
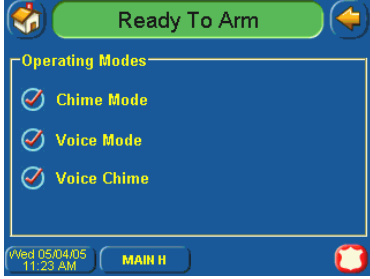
SCREEN	ACTION
	<p>4. Enter your Authorized code. The "Operating Modes" screen is displayed.</p>
	<p>5. Touch the Chime Mode button to turn the Chime Mode on or off. A checkmark appears in the button when the Chime Mode is "ON". Note that it may take a few seconds for the Chime Mode to take effect.</p> <p>6. (6271CV Only) Touch the Voice Mode button to turn the Voice Mode on or off. A checkmark appears in the button with the Voice Mode is "ON" Note that if the Chime Mode and Voice Mode are both selected, the Voice Chime button will automatically be selected.</p> <p>Press the "HOME" or "BACK" button after making your selection. When the TouchCenter exits the "Operating Modes" screen, your selection is saved.</p>



## User Codes

---

### **In This Section**

- ◆ *Introduction to User Code Setup*
- ◆ *How to Access User Setup*
- ◆ *Authority Levels*

---

### **Introduction to User Code Setup**

Each user must be assigned a name with a corresponding 4-digit user code in order to gain access to various features and functions. The TouchCenter can hold the identity for 10 Users in its memory. If additional Users are needed, define the additional Users using the Console Emulation Mode.

Users for the system are programmed in a central user setup location that provides the specific questions for authorization levels assigned to different users. You may want these users to be the same, but there are situations in which you may want a user to have limited capabilities. These capabilities are defined by the Authority Level assigned each user.

### **Authority Levels**

Authority levels define the system functions a particular user can perform. Depending on the authority assigned to you, there are certain system functions you may be prohibited from performing. The following information describes the authority levels available in the TouchCenter and provides the equivalent authority level name that you will find if you are reading your alarm system manuals. The authority levels available in the TouchCenter are as follows:

Touch-Center Authority Level	Functions	Equivalent System Name	
		Residential Systems	Commercial Systems
Installer	Can perform all security functions except can only disarm if code was used to arm, can change Master Code, cannot change other user codes, can access the Central Station Screen options <b>Note:</b> This authority level can not be assigned using the TouchCenter	Installer	Installer
Master	Can perform all security functions, add/delete users in assigned partition, program scheduled events, and change partition master code	Partition Master	Level 1 Master
Normal	Perform security functions (arm, disarm)	Standard User	Level 3 Operator A
Guest	Can arm the system in assigned partitions, but cannot disarm the system unless the system was armed with this code. <b>Note:</b> Do not assign this level if Quick Arm is enabled in the system.	Guest	Level 4 Operator B
No Access	Used to restrict access from a partition.	N/A	N/A





### **How to Access User Setup**

Access User Setup as follows:

1. From the "Home" screen, press the **SECURITY** button. The "Arming" screen is displayed.

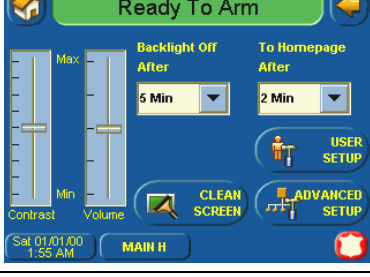

SECTION 5: User Codes

SCREEN	ACTION
	<p>2. Press the <b>MORE CHOICES</b> button on the "Arming" Screen. The "More Choices" screen is displayed.</p>
	<p>3. Press the <b>SETUP</b> button on the "More Choices" screen. The "Setup" screen is displayed.</p>
	<p>4. Press the <b>USER SETUP</b> button on the "Setup" screen. The User Setup screen is displayed.</p>
	

**How to Add a User**

Add a User as follows:

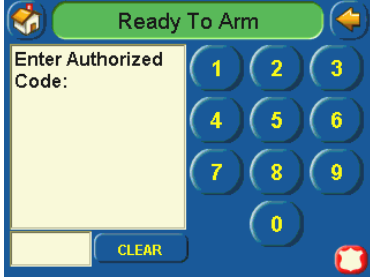
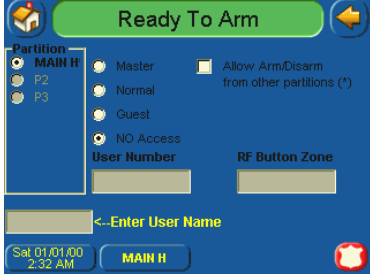
SCREEN	ACTION
	<p>1. To add a user, press the <b>ADD USER</b> button. The "User Authorization" screen is displayed with the instructions "<b>Enter Authorized Code</b>".</p>
	<p>2. Enter your Authorized code. The "User Options" screen is displayed.</p> <p><b>Note:</b> The authorized code for adding users is dependent upon the alarm panel you are interfacing with. Check your alarm panel Installation and Setup Guide to determine who can add users.</p>
	<p>3. Press the box next to <b>Enter User Name</b>. The <b>Enter Data</b> keyboard screen is displayed.</p>

SECTION 5: User Codes

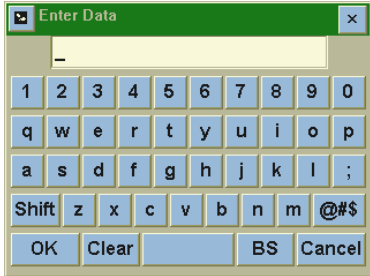
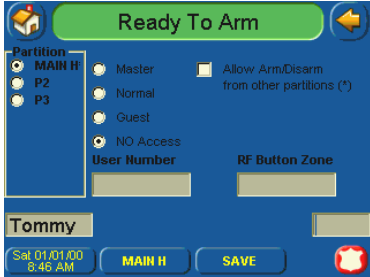
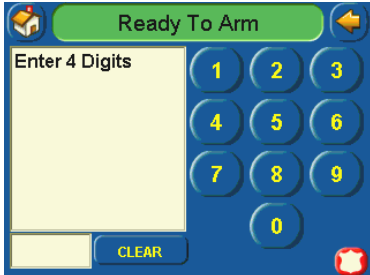
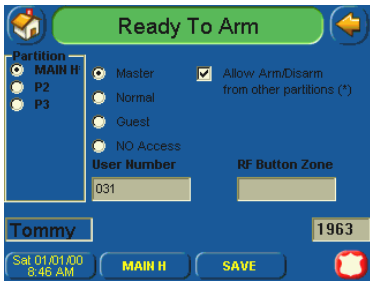

SCREEN	ACTION
	<p>4. Type in the user name (6 characters max.) and press the <b>OK</b> button. The "User Options" screen is displayed with <b>Enter User Code...</b> displayed.</p> <p><b>Notes:</b></p> <ul style="list-style-type: none"> <li>• Use the <b>Shift</b> button for capital letters.</li> <li>• Use the <b>BS</b> (Backspace) button to make corrections.</li> <li>• The <b>@#\$</b> button is not available for use at this time. These characters cannot be saved to the control panel.</li> </ul>
	<p>5. Touch the box next to <b>Enter User Code...</b> The "User Authorization" screen is displayed with the instructions "<b>Enter 4 Digits</b>".</p>
	<p>6. Enter the 4-digit code for this user. The "User Options" screen is displayed with the user's name and code displayed.</p>
	<p>7. Select the partitions, access level, and enter a user number for this user.</p> <p>If assigning this user to wireless key, enter one of the zone numbers of the keyfob (the wireless key must be programmed first before it can be assigned to a user).</p>

SCREEN	ACTION
	<p>8. Press the <b>Save</b> button. The system will save the configuration. When the save is complete, the <b>User Setup</b> screen is displayed with the new user's name shown.</p>

### How to Delete a User

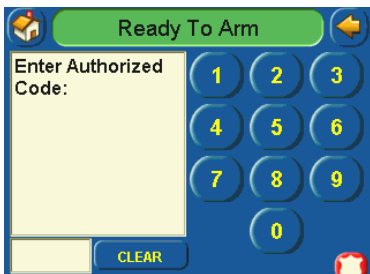
Delete a User as follows:

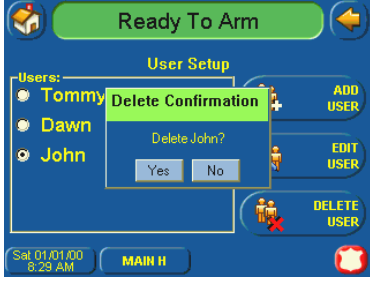
SCREEN	ACTION
	<p>Three selections are available: add a user, edit a user, or delete a user.</p> <p>1. To delete a user, touch the circle next to the user to be deleted and press the <b>DELETE USER</b> button. The "User Authorization" screen is displayed with the instructions "<b>Enter Authorized Code</b>".</p>
	<p>2. Enter your Authorized code. The <b>Confirm Delete</b> screen is displayed.</p> <p><b>Note:</b> The authorized code for deleting, adding, and editing users is dependent upon the alarm panel you are interfacing with. Check your alarm panel Installation and Setup Guide to determine who can delete, add, and edit users.</p>

SCREEN	ACTION
	<p>3. Press the appropriate button. The <b>User Setup</b> screen is displayed.</p>
	



**How to Edit a User**

Edit a User as follows:

**Note:** You can not edit a User's name. To modify a User name, you must delete the User and re-enter User.

SCREEN	ACTION
	<p>Three selections are available: add a user, edit a user, or delete a user.</p> <p>1. To edit a user, touch the circle next to the user to be edited and press the <b>EDIT USER</b> button. The "User Authorization" screen is displayed with the instructions "<b>Enter Authorized Code</b>".</p>

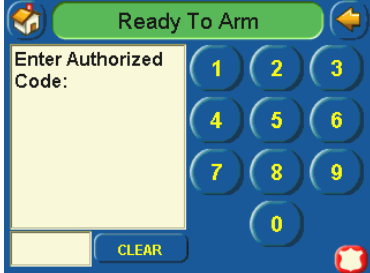
*TouchCenter Installation and Setup Guide*

SCREEN	ACTION
	<p>2. Enter your Authorized code. The “User Options” screen is displayed.</p> <p><b>Note:</b> The authorized code for deleting, adding, and editing users is dependent upon the alarm panel you are interfacing with. Check your alarm panel Installation and Setup Guide to determine who can delete, add, and edit users.</p>
	<p>3. Select whatever options you wish to select for this user and press the <b>Save</b> button. The configuration changes are saved and you are returned to the <b>User Setup</b> screen.</p>
	

## Maintenance

.....

### In This Section

- ◆ *About TouchCenter Maintenance*     ◆ *Routine Care*
  - ◆ *How to Clean the TouchCenter*
- .....

### About TouchCenter Maintenance

With the exception of normal cleaning, the TouchCenter is maintenance free.

### How to Clean the TouchCenter

**IMPORTANT:** Do not use an abrasive cleaning agent or abrasive cloth when cleaning the TouchCenter or damage to the touch screen may occur.



The **Emergency** screen cannot be accessed while running in the clean screen mode.

Clean the TouchCenter as follows:

1. From the "Home" screen, press the **SECURITY** button. The "Arming" screen is displayed.

SCREEN	ACTION
	<ol style="list-style-type: none"> <li>2. Press the <b>MORE CHOICES</b> button. The "More Choices" screen is displayed.</li> </ol>

*TouchCenter Installation and Setup Guide*

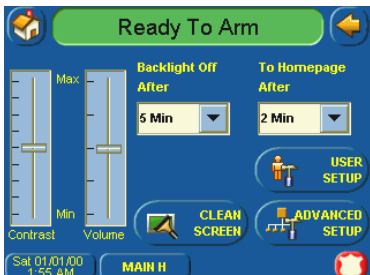
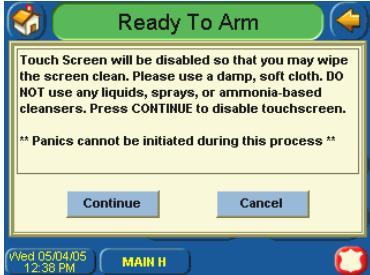
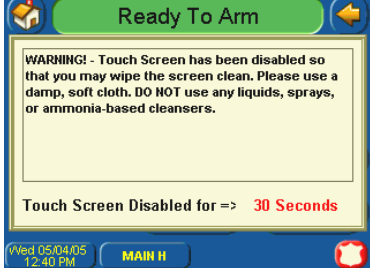
SCREEN	ACTION
	<p>3. Press the <b>SETUP</b> button on the "More Choices" screen. The "Setup" screen is displayed.</p>
	<p>4. Press the <b>CLEAN SCREEN</b> button. A pop-up window displaying <b>"Touch Screen will be disabled so that you may wipe the screen clean. Please use a damp, soft cloth. DO NOT use any liquids, sprays, or ammonia-based cleansers. Press CONTINUE to disable touchscreen."</b></p> <p>When the <b>Continue</b> button is pressed the <b>"Touch Screen Disabled for =&gt; 30 Seconds"</b>. During these 30 seconds the touch screen should be wiped clean of fingerprints using a mild soap solution and a soft cloth. When the counter reaches zero, the window automatically closes and the touch screen is active.</p> <p><b>Note:</b> Do not spray cleaning agent directly on the screen, spray it on cloth then wipe surface area.</p>
	
	



### **Routine Care**

- Treat the components of the security system as you would any other electrical equipment. Do not slam sensor-protected doors or windows.
- Keep dust from accumulating on the keypad and all protective sensors, particularly on motion sensors and smoke detectors.
- The keypad case and sensors should be carefully dusted with a dry soft cloth. ***Do not spray water or any other fluid on the units.***





## Diagnosics



### About Diagnosics

A series of diagnostic tests are provided that allows verification of correct operation of the TouchCenter and its connections to the security system. There are a total of three diagnostic tests.



### How to Access the Diagnosics

To access diagnosics, do the following:

1. From the "Home" screen, press the SECURITY button. The "Arming" screen is displayed.

SCREEN	ACTION
	<ol style="list-style-type: none"> <li>2. From the "Arming" screen press the <b>MORE CHOICES</b> button. The "More Choices" screen is displayed.</li> </ol>
	<ol style="list-style-type: none"> <li>3. Press the <b>SETUP</b> button on the "More Choices" screen. The "Setup" screen is displayed.</li> </ol>

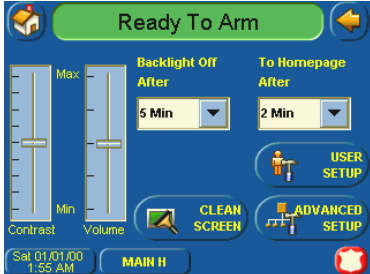
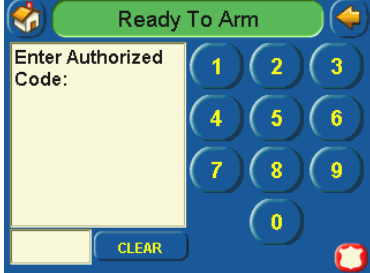
SECTION 7: Troubleshooting

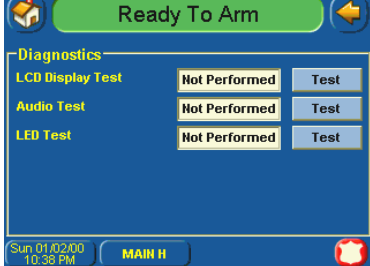
SCREEN	ACTION
	<p>4. Press the <b>Advanced Setup</b> button on the "Setup" screen. The <b>Enter Authorized Code</b>: authorization screen is displayed.</p>
	<p>5. Enter your 4-digit Installer code. The "Advanced Setup" menu screen is displayed.</p>
	<p>6. Press the <b>Keypad Test</b> button on the "Advanced Setup" menu screen. The "Diagnostics" screen is displayed.</p>
	

## Performing Diagnostics

Select any diagnostic test from the Diagnostics screen by pressing its associated **Test** button. All or any individual test may be run when you access the Diagnostics screen; however, each test must be performed one at a time.

At any time when a test is not being performed, you can press:

- the back button to return to the previous screen, or
- the home button to return to your home page.



Once the Diagnostics screen is exited, subsequent entry to this screen displays all test options as "Not Performed."

---

## LCD Display Test

Perform the LCD Display Test as follows:





The **Emergency** screen cannot be accessed while running the LCD Display Test.

---

SCREEN	ACTION
	<p>When you press the Test button associated with the LCD Display Test, a series of different screens will be displayed. After each type of display, you will be asked if the display was proper. If the response to all questions is yes, the LCD Display Test message area of the Diagnostics screen will display "Passed".</p>

**Audio Test**

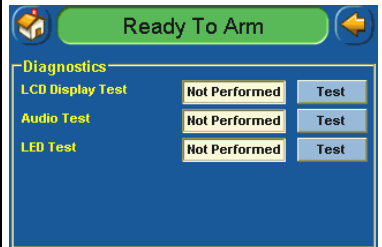
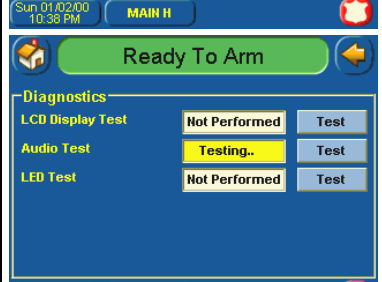
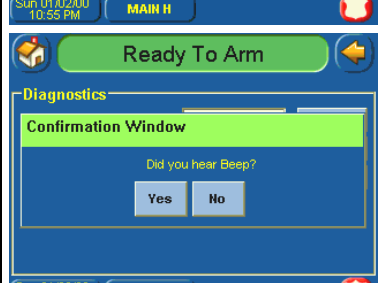
Perform the Audio Test as follows:

SCREEN	ACTION
	<p>When you press the <b>Test</b> button associated with the Audio Test, "Testing.." is displayed in the test status column on the "Diagnostics" screen while beeps sound from the speaker. At the conclusion of the test, a pop-up "Confirmation Window" is displayed in the center of the "Diagnostics" screen.</p>
	<p>Within the Confirmation Window the question "Did you hear Beep?" is displayed.</p> <p>When you press the <b>Yes</b> button, "Passed" is displayed in the test status column on the "Diagnostics" screen.</p>
	<p>When you press the <b>No</b> button, "Failed." is displayed in the test status column on the "Diagnostics" screen.</p>
	

**LED Test**

Perform the LED Test as follows:

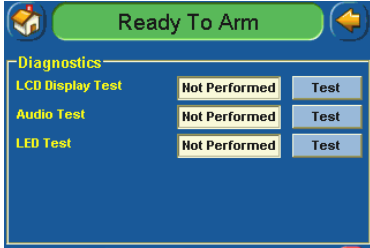
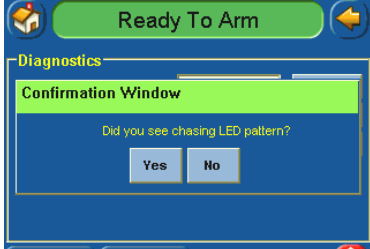
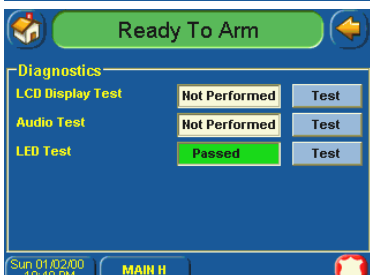
SCREEN	ACTION
	<p>1. When you press the <b>Test</b> button associated with the LED Test, "Testing.." is displayed in the test status column on the "Diagnostics" screen while the 3 LEDs light sequentially, top to bottom (red, green, amber), 5 times. At the conclusion of the test, a pop-up "Confirmation Window" is displayed in the center of the "Diagnostics" screen.</p>
	<p>2. Within the Confirmation Window the question "Did you see chasing LED pattern?" is displayed. If you press the <b>Yes</b> button, "Passed" is displayed in the test status column on the "Diagnostics" screen. If you press the <b>No</b> button, "Failed" is displayed in the test status column on the "Diagnostics" screen.</p>
	



## Safe Mode

---

### In This Section

- ◆ *About the Safe Mode*
  - ◆ *Operating in the Safe Mode*
  - ◆ *Entering the Safe Mode*
  - ◆ *Exiting the Safe Mode*
- 

### About the Safe Mode

The TouchCenter contains a Safe Mode of operation. In the rare event that the TouchCenter cannot successfully communicate in its graphic mode with the control panel, the Safe Mode is a backup mode that ensures that you can communicate with your system. In this mode, the TouchCenter operates much like a standard non-graphic keypad so that you can control your system until the problem is corrected.



- DO NOT perform panel programming while in the Safe Mode. Performing panel programming while in the Safe Mode may cause the panel and TouchCenter to become out of sync.
  - DO NOT use several hardwired motion detectors in high traffic locations. The high quantity of signals received by the panel may cause the TouchCenter to enter the Safe Mode.
- 

### Entering the Safe Mode

The Safe Mode may be automatically entered by the TouchCenter program on a communication failure or may be entered manually on command. The following paragraphs describe these entry processes.

#### Automatic Entry

In the rare event that the TouchCenter cannot successfully communicate in its graphic mode with the control panel, the TouchCenter presents you with a message of “Problems detected. Start Keypad in Safe Mode?” and requests a “Yes” or “No” response. If you answer with “Yes”, the TouchCenter will go into the Safe Mode. If you answer with “No”, the TouchCenter will try communicating with the panel again. After 3 consecutive times of receiving no response, the TouchCenter will enter the Safe Mode.



**Note:** Use care when providing the “Yes” or “No” response. Touching the screen outside the prescribed area may cause the background to come to the front. If this occurs, the Yes/No message that disappeared will time out in 30 seconds even though it is not visible. Then the keypad will reset into the Normal Mode (or Safe Mode if this is the third time that the warning message appeared).

**Manual Entry**



To manually put the TouchCenter into the Safe Mode of operation:

**Note:** ONLY enter the Safe Mode from the Normal Mode. Entering the Safe Mode from the Demo Mode may result in incorrect display of the Emergency Function keys.

1. From the "Home" screen, press the **SECURITY** button. The "Arming" screen is displayed.

SCREEN	ACTION
	<p>2. Press the <b>MORE CHOICES</b> button. The “More Choices” screen is displayed.</p>
	<p>3. Press the <b>SETUP</b> button on the “More Choices” screen. The “Setup” screen is displayed.</p>

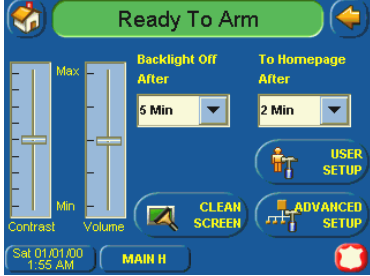
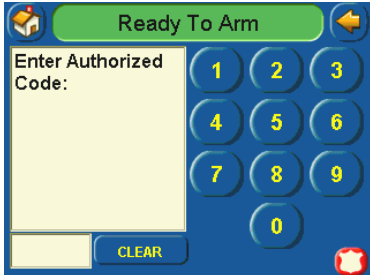
SECTION 8: Safe Mode

SCREEN	ACTION
	<p>4. Press the <b>ADVANCED SETUP</b> button. The <b>Enter Authorized Code:</b> authorization screen is displayed.</p>
	<p>5. Enter your 4-digit Installer code. The "Advanced Setup" menu screen is displayed.</p>
	<p>6. Press the <b>Central Station</b> button. The "Central Station" menu screen is displayed.</p>
	<p>7. Press the <b>Options</b> button. The "Options" menu screen is displayed.</p>

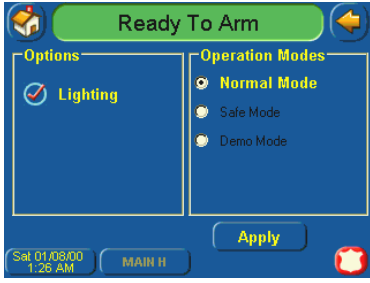
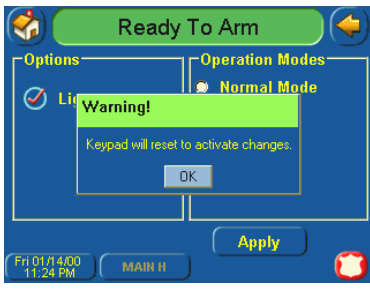
SCREEN	ACTION
	<p>8. Select <b>Safe Mode</b> and then press the <b>Apply</b> button. The “Warning” message is displayed.</p>
	<p>9. Press the <b>OK</b> button. The TouchCenter will reset and restart in the Safe Mode.</p>

### Operating in the Safe Mode

While in the Safe Mode, the Home screen will display the Security button, Panic Button, and a message at the bottom of the screen as shown below:



This is a limited mode of operation. While in this mode:

- You can use the Security button to access the Console Emulation Mode of operation to try to clear your faults, disarm the system, or enter additional Alpha Keypad commands specified in you panel User and Installation Guides. You can perform almost all functions that you can perform from a standard non-graphic alpha keypad.
- You can depress the “Panic” key and generate Emergency Messages as defined in the panels home partition for this TouchCenter.

- The Armed and Ready LEDs on the front of the TouchCenter will indicate the TouchCenter's home partition status. The Message (6271CV) or Trouble (6271C) LED is not active in the Safe Mode.
- The Chime mode will function in the Safe Mode: however, you will not have Voice, Voice Chime, or Message capability if using the 6271CV.

### **Exiting the Safe Mode**

To Exit the Safe Mode:

1. Press the ! SAFE MODE ! bar. You will be presented with the following popup message:

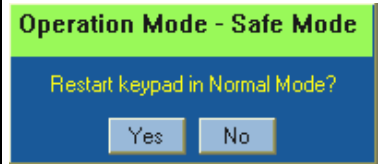
 <p><b>Operation Mode - Safe Mode</b></p> <p>Restart keypad in Normal Mode?</p> <p>Yes No</p>	<ol style="list-style-type: none"><li>2. Press the <b>Yes</b> button to return to the Normal Mode of operation. The TouchCenter will reset and restart in the Normal Mode.</li></ol>
--	--



## Specifications

.....

### Specifications

MECHANICAL	
Dimensions:	
Width:	7 1/4 inches
Height:	5 inches
Depth:	1 3/8 inches
ELECTRICAL	
Operating Voltage:	+12VDC
Current Drain:	
Backlight OFF, Sound OFF	105mA
Backlight ON, Sound OFF	341mA
Backlight ON, Sound ON	410mA





## Index

.....

About the TouchCenter.....	1-1
Address Change .....	4-3, 4-6
Central Station Screen	
Accessing .....	4-4
Chime Mode .....	4-22
Cleaning .....	6-1
Code Authority	
View.....	4-10
Compatibility .....	1-2
Contrast Adjustment.....	4-13
Diagnostics.....	7-2
Audio Test.....	7-5
LCD Display .....	7-4
LED Test.....	7-6
Performing .....	7-4
ECP Error .....	1-2
Front Panel LEDs.....	3-1
Initialization.....	4-3
Maintenance .....	6-1
Cleaning.....	6-1
Routine Care.....	6-3
Mounting and Wiring.....	2-1
Night Setup.....	4-8
Operating Modes	
Chime .....	4-22
Panel Configuration	
Delete .....	4-12
View.....	4-11
Power Up.....	4-3
Routine Care.....	6-3
Safe Mode .....	8-1
Screen Security	
Edit .....	4-9
View.....	4-9
Setup	
Contrast.....	4-13
Specifications.....	9-1
Electrical.....	9-1
Mechanical.....	9-1

*TouchCenter Installation and Setup Guide*

---

System Features .....	1-1
System Options	
Selecting .....	4-7
Troubleshooting .....	7-1
Diagnostics .....	7-2
Performing Diagnostics.....	7-4
User	
Adding .....	5-4
Deleting .....	5-6
Editing.....	5-7
User Code Setup	
Access .....	5-2
Voice Mode.....	4-22
Word List .....	4-2

## Notes

## Notes

## Notes

## Notes

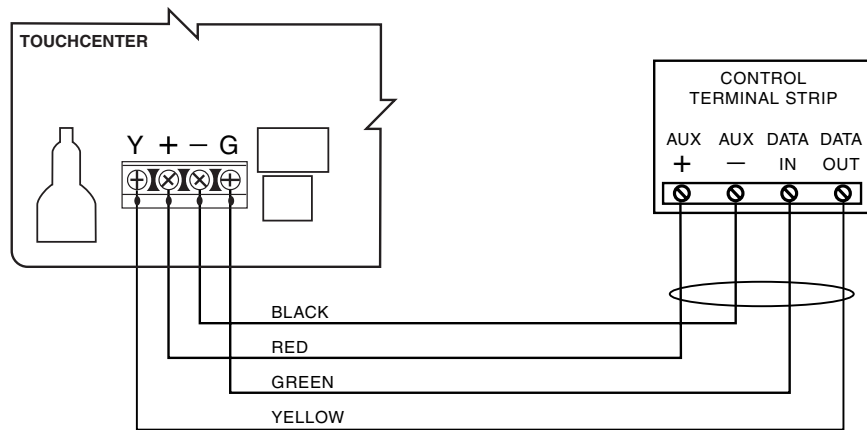

POWERING THE TOUCHCENTER KEYPAD FROM THE CONTROL

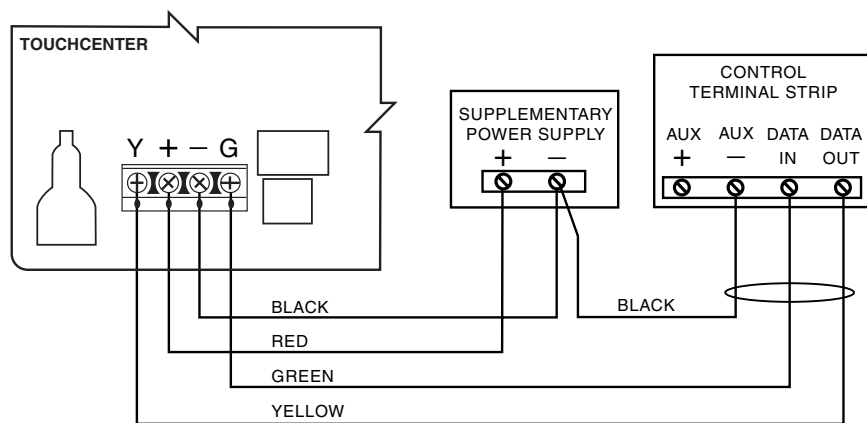

POWERING THE TOUCHCENTER FROM A SUPPLEMENTARY POWER SUPPLY

6271CV-008-V0

**UL** Use a Listed Class 2 power supply suited for the application.

## Summary of Connections

### LIMITED WARRANTY

Honeywell International Inc., acting through its ADEMCO business ("Seller"), 165 Eileen Way, Syosset, New York 11791, warrants its product(s) to be in conformance with its own plans and specifications and to be free from defects in materials and workmanship under normal use and service for 24 months from the date stamp control on the product(s) or, for product(s) not having an ADEMCO date stamp, for 12 months from date of original purchase unless the installation instructions or catalog sets forth a shorter period, in which case the shorter period shall apply. Seller's obligation shall be limited to repairing or replacing, at its option, free of charge for materials or labor, any product(s) which is proved not in compliance with Seller's specifications or proves defective in materials or workmanship under normal use and service. Seller shall have no obligation under this Limited Warranty or otherwise if the product(s) is altered or improperly repaired or serviced by anyone other than ADEMCO factory service. For warranty service, return product(s) transportation prepaid, to ADEMCO Factory Service, 165 Eileen Way, Syosset, New York 11791.

THERE ARE NO WARRANTIES, EXPRESS OR IMPLIED, OF MERCHANTABILITY, OR FITNESS FOR A PARTICULAR PURPOSE OR OTHERWISE, WHICH EXTEND BEYOND THE DESCRIPTION ON THE FACE HEREOF. IN NO CASE SHALL SELLER BE LIABLE TO ANYONE FOR ANY CONSEQUENTIAL OR INCIDENTAL DAMAGES FOR BREACH OF THIS OR ANY OTHER WARRANTY, EXPRESS OR IMPLIED, OR UPON ANY OTHER BASIS OF LIABILITY WHATSOEVER, EVEN IF THE LOSS OR DAMAGE IS CAUSED BY THE SELLER'S OWN NEGLIGENCE OR FAULT.

Seller does not represent that the product(s) it sells may not be compromised or circumvented; that the product(s) will prevent any personal injury or property loss by burglary, robbery, fire or otherwise; or that the product(s) will in all cases provide adequate warning or protection. Customer understands that a properly installed and maintained alarm system may only reduce the risk of a burglary, robbery, fire, or other events occurring without providing an alarm, but it is not insurance or a guarantee that such will not occur or that there will be no personal injury or property loss as a result. CONSEQUENTLY, SELLER SHALL HAVE NO LIABILITY FOR ANY PERSONAL INJURY, PROPERTY DAMAGE OR OTHER LOSS BASED ON A CLAIM THAT THE PRODUCT(S) FAILED TO GIVE WARNING. HOWEVER, IF SELLER IS HELD LIABLE, WHETHER DIRECTLY OR INDIRECTLY, FOR ANY LOSS OR DAMAGE ARISING UNDER THIS LIMITED WARRANTY OR OTHERWISE, REGARDLESS OF CAUSE OR ORIGIN, SELLER'S MAXIMUM LIABILITY SHALL NOT IN ANY CASE EXCEED THE PURCHASE PRICE OF THE PRODUCT(S), WHICH SHALL BE THE COMPLETE AND EXCLUSIVE REMEDY AGAINST SELLER.

This warranty replaces any previous warranties and is the only warranty made by Seller on this product(s). No increase or alteration, written or verbal, of the obligations of this Limited Warranty is authorized.

## Honeywell



PREK6248 8/05 Rev. A

165 Eileen Way, Syosset, NY 11791  
Copyright © 2005 Honeywell International Inc.  
[www.honeywell.com/security](http://www.honeywell.com/security)